

LEGO DIGITAL DESIGNER 4.2

Model Name:
Robot Trophy

Number of Bricks: 145

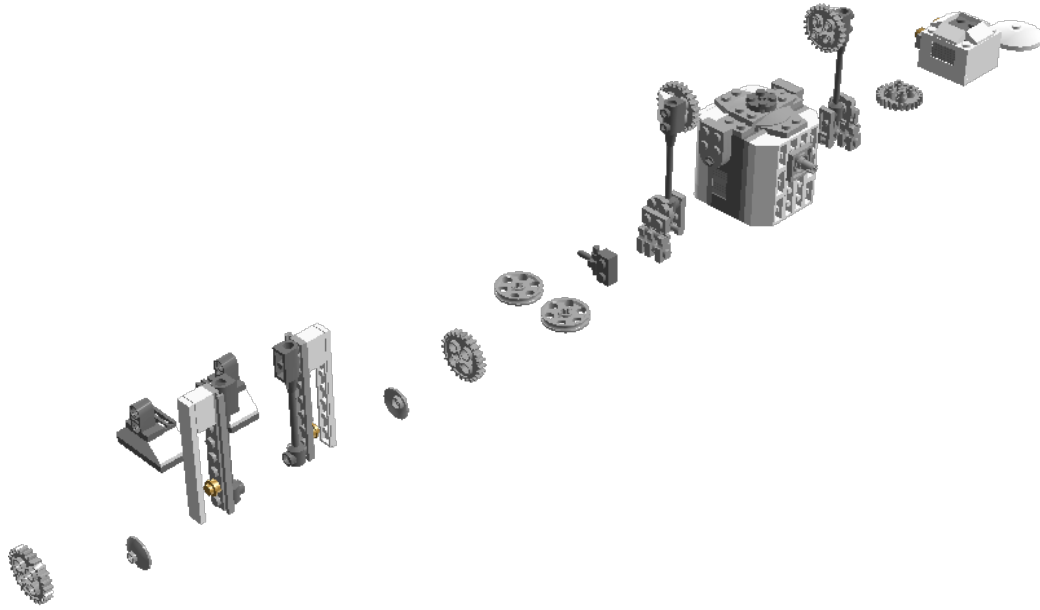

Step 1 of 63

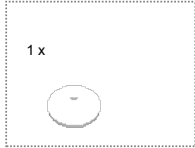

Step 2 of 63



Step 3 of 63

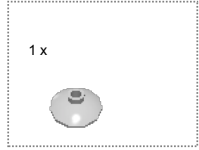

Step 4 of 63



Step 5 of 63



Step 6 of 63

1 x



1 x



1 x



1 x

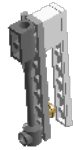

Step 7 of 63



Step 8 of 63

1 x



Step 9 of 63

1 x



1 x



1 x



1 x



Step 10 of 63

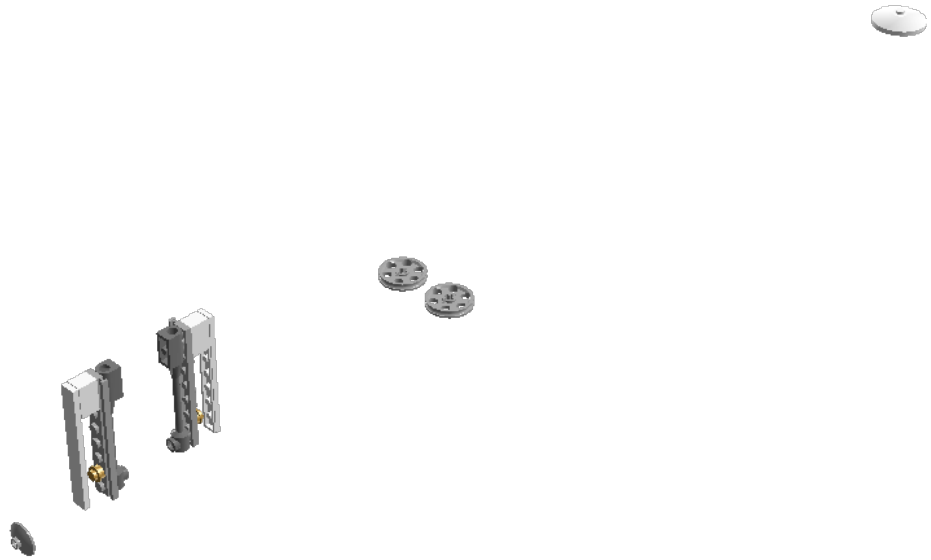

Step 11 of 63

2 x



1 x



1 x



Step 12 of 63

2 x



1 x



1 x



Step 13 of 63

1 x



1 x



1 x



1 x



Step 14 of 63

2 x



1 x



1 x



Step 15 of 63

1 x



1 x



1 x



Step 16 of 63

1 x



1 x



2 x



Step 17 of 63



Step 18 of 63



Step 19 of 63

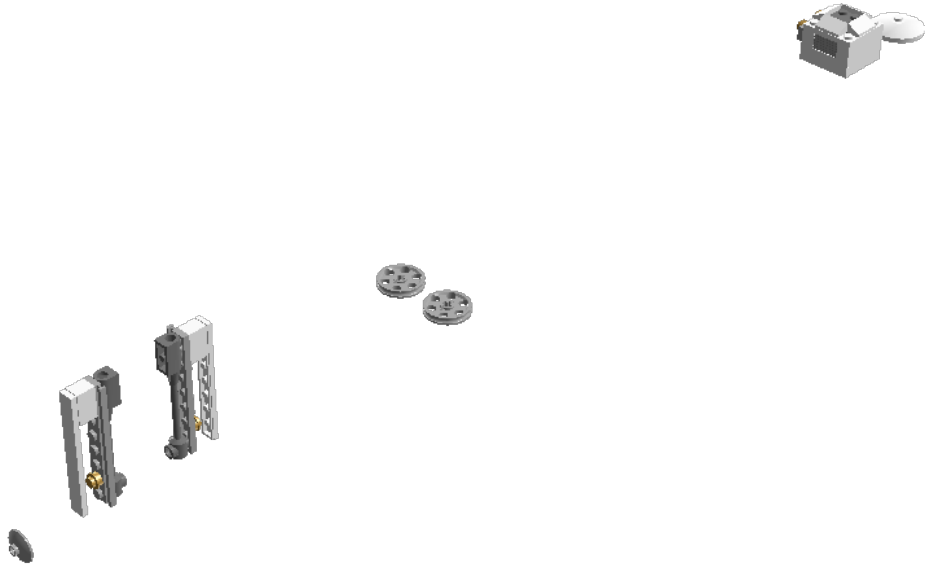

Step 20 of 63

1 x

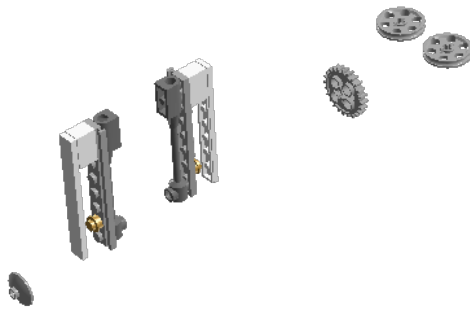

Step 21 of 63

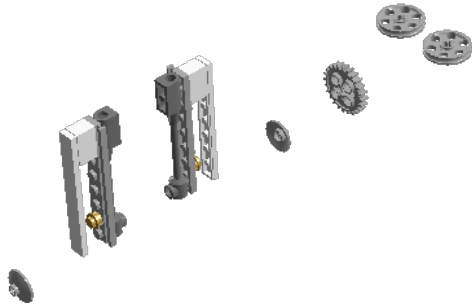
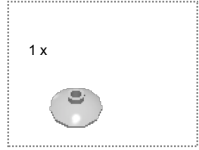

Step 22 of 63

1 x

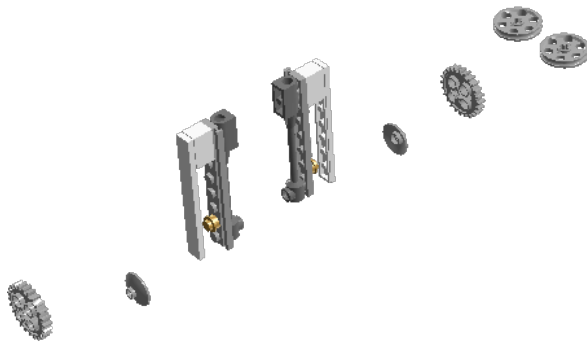

Step 23 of 63

1 x



1 x



1 x



Step 24 of 63

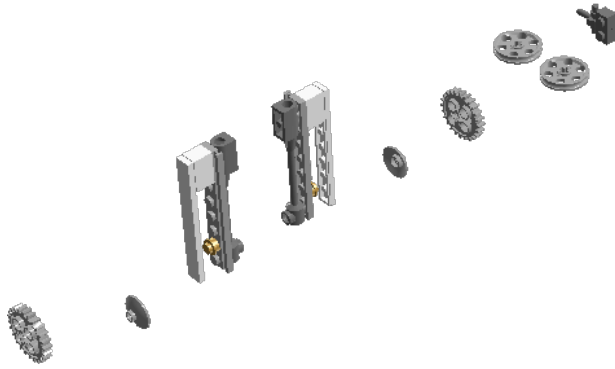

Step 25 of 63



Step 26 of 63

2 x



1 x



1 x



Step 27 of 63

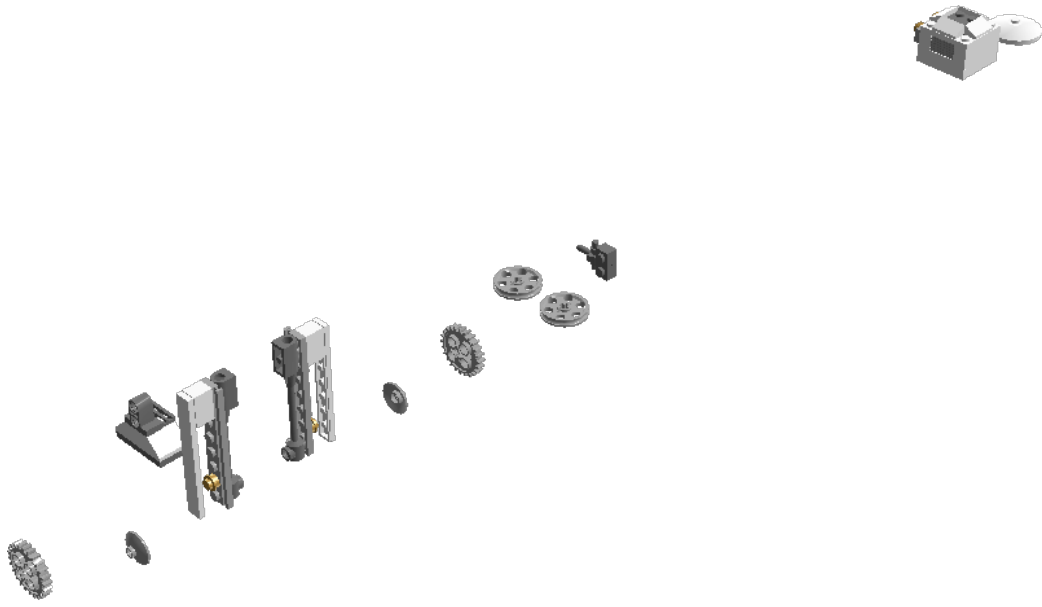

Step 28 of 63



Step 29 of 63

2 x



1 x



1 x



Step 30 of 63

.....

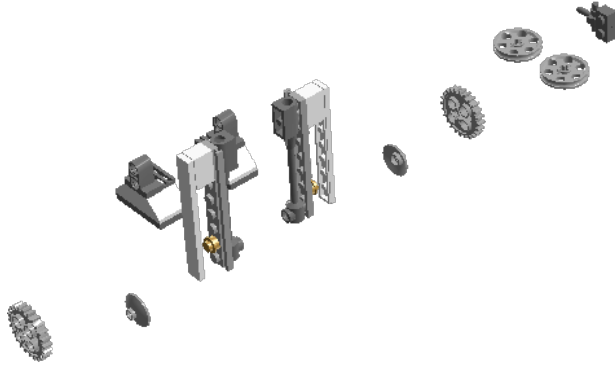

Step 31 of 63

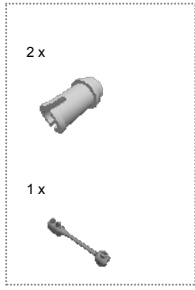

Step 32 of 63

1 x



2 x



1 x



Step 33 of 63

1 x



1 x



1 x



Step 34 of 63

3 x



1 x



Step 35 of 63



Step 37 of 63

1 x





Step 38 of 63

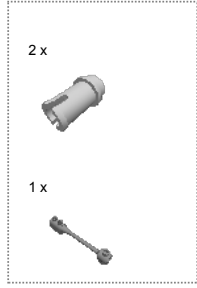

Step 40 of 63



Step 41 of 63

- 1 x 
- 2 x 
- 1 x 



Step 42 of 63

1 x



1 x



1 x



Step 43 of 63

3 x



1 x



Step 44 of 63



Step 46 of 63

1 x



2 x



1 x

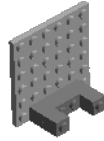

Step 47 of 63

1 x



1 x



1 x

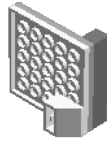

Step 48 of 63

1 x



2 x



1 x

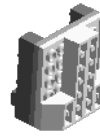

Step 49 of 63

2 x



1 x



1 x

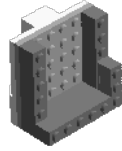

Step 50 of 63

1 x



2 x



Step 51 of 63

1 x



2 x



1 x



Step 52 of 63

1 x



1 x



1 x



Step 53 of 63

1 x



2 x



Step 54 of 63



Step 55 of 63

1 x



2 x



Step 56 of 63



Step 57 of 63

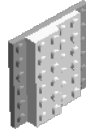
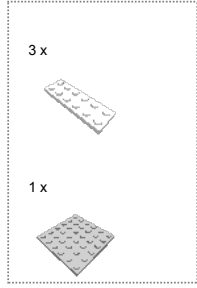

Step 58 of 63

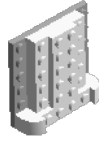
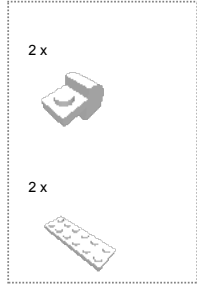

Step 59 of 63

1 x



1 x



2 x



Step 60 of 63

1 x



2 x



1 x



Step 61 of 63

2 x



1 x



1 x



Step 62 of 63

.....



2 x  4211098 BRICK 1X1 - Dark Stone Grey

2 x  300501 BRICK 1X1 - White

1 x  4211088 BRICK 1X2 - Dark Stone Grey

2 x  300401 BRICK 1X2 - White

1 x  4211103 BRICK 1X4 - Dark Stone Grey

1 x  301001 BRICK 1X4 - White

3 x  4211100 BRICK 1X6 - Dark Stone Grey

2 x  300901 BRICK 1X6 - White

4 x  4558955 BRICK 1X1 W. 1 KNOB - Dark Stone Grey

4 x  4210636 PROFILE BRICK 1X2 - Dark Stone Grey

2 x  4211087 BRICK 1X2 W. HORIZONTAL SNAP - Dark Stone Grey

1 x  4210725 BRICK 1X4 W. 4 KNOBS - Dark Stone Grey

2 x  4244372 ROOF TILE 1X1X2/3, PC - Medium Stone Grey

12 x  4244370 ROOF TILE 1X1X2/3, PC - White

4 x  303901 ROOF TILE 2X2/45° - White

6 x  366001 ROOF TILE 2X2/45 INV. - White

4 x  609101 BRICK W. ARCH 1X1X1 1/3 - White

2 x  608101 BRICK W. BOW 4X1X1 1/3 - White

1 x  4211063 PLATE 1X2 - Dark Stone Grey

2 x  302301 PLATE 1X2 - White

2 x  4211451 PLATE 1X2 W. 1 KNOB - Medium Stone Grey

1 x  4211094 PLATE 2X2 - Dark Stone Grey

4 x  371001 PLATE 1X4 - White

2 x  4211065 PLATE 2X4 - Dark Stone Grey

5 x  379501 PLATE 2X6 - White

2 x  303101 PLATE 4X4 - White

2 x  4211474 PLATE 6X6 - Medium Stone Grey

1 x  395801 PLATE 6X6 - White

4 x  4523159 PLATE 1X1 ROUND - Warm Gold

1 x  4211042 PLATE 2X2 ROUND - Dark Stone Grey

2 x  4211475 PLATE 2X2 ROUND - Medium Stone Grey















2 x  4211512 SATELLITE DISH Ø16 - Medium Stone Grey

1 x  396001 ROUND PLATE Ø32X6.4 - White

1 x  4211611 HOOVERBOARD 6X6X2/3 - Medium Stone Grey

6 x  4210631 RADIATOR GRILLE 1X2 - Dark Stone Grey

6 x  4517961 PLATE 1X1 W. HOLDER - Medium Stone Grey

- | | | |
|--|---|--|
| 4 x  243101 FLAT TILE 1X4 - White | 2 x  4515369 PLATE 1X2 W/SHAFT Ø3.2 - Medium Stone Grey | 1 x  4210660 PLATE 1X2 W. STICK - Dark Stone Grey |
| 2 x  4211632 PLATE 1X2 W. STICK - Medium Stone Grey | 2 x  416201 FLAT TILE 1X8 - White | 4 x  4211419 COUPLING PLATE 2X2 - Medium Stone Grey |
| 1 x  317601 COUPLING PLATE 2X2 - White | 2 x  4210763 T-BEAM W. PLATE 1X2 W. TUBE - Dark Stone Grey | 1 x  4211763 PLATE 2X2 INVERTED W. SNAP - Medium Stone Grey |
| 2 x  4211498 PLATE 1X8 WITH RAIL - Medium Stone Grey | 12 x  4211483 CONNECTOR PEG W. KNOB - Medium Stone Grey | 1 x  4222196 STICK Ø 3.2 W. HOLDER - Dark Stone Grey |
| 2 x  4211544 WEDGE-BELT WHEEL Ø24 - Medium Stone Grey | 5 x  4211565 GEAR WHEEL Z24 - Medium Stone Grey | 4 x  4210815 BRICK W. SHAFT 1X8X1 - Dark Stone Grey |

© 2012 The LEGO Group. All rights reserved.
 Use of the LEGO Digital Designer html print tool, signifies your agreement to the terms of use.